





- Cilindro di alta sicurezza con sistema di cifratura meccanico a 11 perni attivi
- Spine anti-trapano, presenti nello statore e nel rotore

- PIN UNICO anti-bump 

- Sistema con chiave da cantiere 

- Chiavi in ottone
- Cam DIN 30° (C, P, Q)
- Finitura cromo satinata e ottone

- Carta di proprietà numerata 
- Chiave con profilo brevettato 

- Esecuzioni speciali: KA - CA - TANDEM

- Tipologia disponibile:



- C chiave-chiave
- M mezzo cilindro
- P pomolo-chiave
- Q predisposto al pomolo-chiave

- High security cylinder with 11 active pins mechanical coding system
- Anti-drill pins in the body and plug

- PIN UNIQUE anti-bump 

- Site Key System 

- Brass keys
- Cam DIN 30° (C, P, Q)
- Chrome satin and brass finishing

- Numbered property card 
- Protected key duplicable 

- Special executions: KA - CA - TANDEM

- Available in versions:

- C key-key
- M half cylinder
- P knob-key
- Q knob-key predisposition



ANTI-BUMP
ANTI-BUMP



ANTI-TRAPANO
ANTI-DRILL



ANTI-PICK
ANTI-PICK



ANTI-SPEZZAMENTO
ANTI-SNAP



Soddisfa la norma
UNI EN 1303:2005/EC:2008

Meets the standards of the
UNI EN 1303:2005/EC:2008

DURABILITY (min 4 - max 6) : EVOK 22 = 6
KEY RELATED SECURITY (min 1 - max 6) : EVOK 22 = 5
ATTACK RESISTANCE (min 0 - max 2) : EVOK 22 = 1

1	6	0	1	0	C	5	1
---	---	---	---	---	---	---	---

EVOK 22

L'EVOLUZIONE DEL CILINDRO

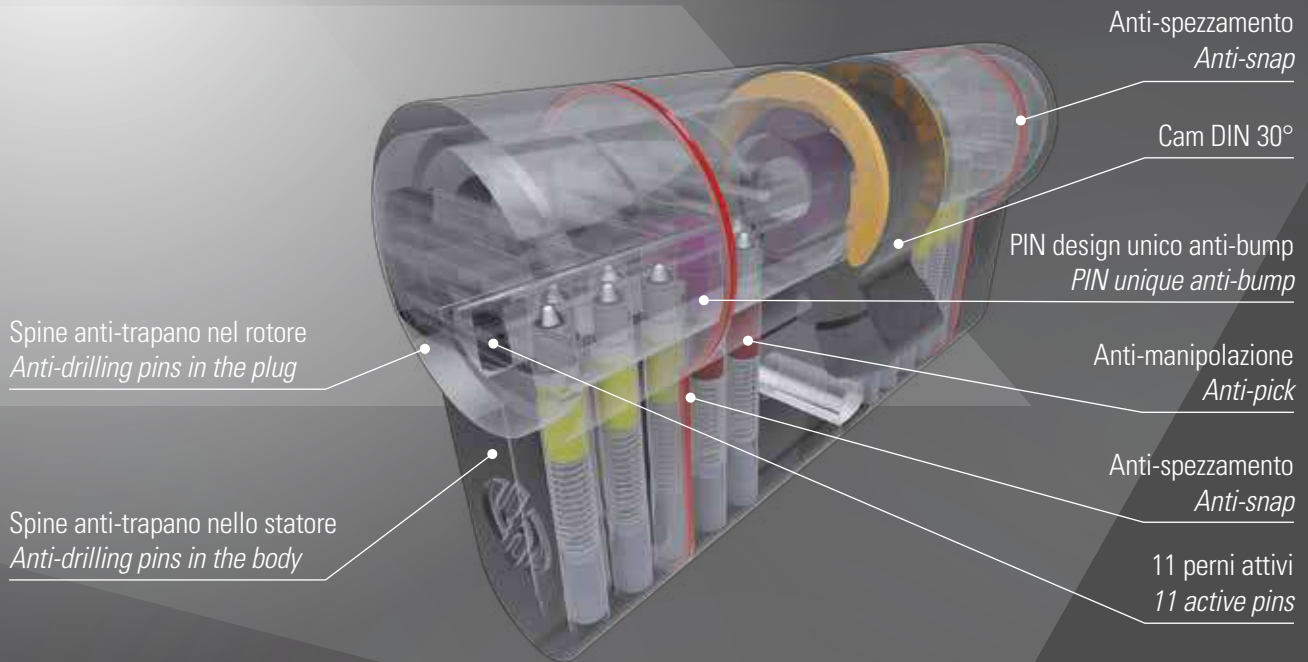

Security card per la duplicazione autorizzata delle chiavi Securemme.

La chiave con profilo brevettato è duplicabile presso i centri autorizzati su presentazione della card e di una chiave originale. Per la Vostra sicurezza si consiglia di conservare la card in luogo sicuro.

Security card for authorized duplication of Securemme keys.

The patented key can be legally arranged exclusively in our authorized centers upon presentation of the personal card and one original key. For your personal safety, we advise to keep the card in a safe place.

DOTAZIONE: 1 chiave da cantiere "C" con inserto rosso, 3/5 inserti colorati, 1 vite M5x70 mm. Nella busta sigillata 3/5 chiavi e 1 security card.

SISTEMA CON CHIAVE DA CANTIERE

Le chiavi padronali contenute nella busta sigillata disattivano automaticamente e definitivamente la chiave da cantiere. Dopo il suo utilizzo si consiglia la distruzione della chiave da cantiere.

SUPPLY: 1 construction key "C" with red insert, 3/5 colored inserts, 1 M5x70mm screw. In the sealed bag 3/5 keys and 1 security card.

SITE KEY SYSTEM

The definitive keys in the sealed bag automatically and definitively deactivate the site key. After this operation the destruction of the site key is recommended.

PERSONALIZE YOUR CYLINDER

Forma ergonomica della chiave e inserto removibile. Design e sistema brevettato. Personalizza EVOK 22, richiedendo il tuo logo sull'inserto della chiave. L'inserto è disponibile in vari colori.

Ergonomic shape of the key and removable insert. Patented design and system. Personalize EVOK 22, requiring your brand on the key insert. The insert is available in various colors.

